

THE FULL UNDERGROUND DISTRIBUTION TRANSFORMER IN PRACTICE

Frank de Groot
Liandon – The Netherlands
frank.de.groot@alliander.com

Maarten van Riet
Liandon – The Netherlands
maarten.van.riet@alliander.com

Gerard Buisman
Liandon – The Netherlands
gerard.buisman@alliander.com

ABSTRACT

DSO's have difficulties allocating new distribution stations in city centres.

In response Liandon is developing a fully underground compartment for distribution transformers. This paper describes the development including the design, thermal testing and the results of testing in a real live environment that is being executed at this moment.

INTRODUCTION

In large city centres Distribution System Operators are encountering difficulties finding suitable locations for distribution stations. New stations are necessary because of new customers and a rising demand on power. Local authorities are becoming less tolerant about allocating distribution stations in public space and stations inside buildings are often less economic. A solution is using compact underground stations.

Liandon is working on a small size underground distribution station with no parts, like ventilation shafts, above ground level. The station will not be a traditional man-accessible underground room but consists of a compartment for a transformer and one for the low voltage switchgear. The LV compartment is a standard product. Design and construction of the transformer compartment is fully new.

GRID CONFIGURATION AND CAPACITY

Fitting in the grid

This type of station is designed to be operated without medium voltage switchgear. The goal is supporting the existing grid. In the existing grid there are a lot of stations in which it is possible to connect the MV-cable that feeds the underground transformer station.

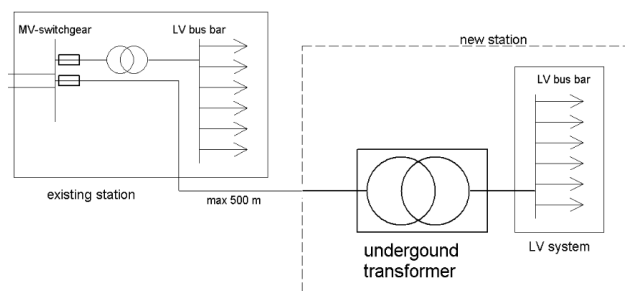

Figure 1: Grid connection

An additional advantage is the great liberty of allocating this kind of station. Feeding the low voltage grid can be optimized so that investments in the LV grid can be minimized.

Capacity

Part of the development is determining the ideal capacity of this kind of distribution station. An analysis of the capacity and load of several distribution stations in an average community has given the following conclusion: In 88 percent of the stations a 10/0,4 kV transformer no larger than 400 kVA is used. The maximum capacity that is used for supplying the LV grid is 630 kVA. The ideal capacity for the underground station is set at **400 kVA**, a possibility for 630 kVA is attractive but no more than a wish.

DESIGN

The following issues need to be taken into consideration when placing a transformer in an underground structure.

Weak soil

The western part of the Netherlands consists of weak soil under sea level. For underground compartment risks are possible sinking due to extensive mass and floating due to upward forces from groundwater.

Measures against sinking

Two measures have been taken to ensure that the compartment and surrounding pavement will not sink:

- The compartment has been equipped with several mounting eyes which make it possible to attach the object to a concrete foundation. In the live test a concrete structure with piles was made, which gives the advantage that the foundation can be made location specific.
- Around the outer cover a tongue-construction ensures that the pavement directly next to the cover can't sink.

Measures against floating

A calculation was made to determine the risk of floating in case of no foundation.

There is a risk of floating when the upward force (Archimedes) from the groundwater exceeds the gravitational force due to the mass of the compartment with or without the transformer. The upward force depends on the water displacement causing it to be proportional to the volume of the part of the compartment that is inside the groundwater.

The outcome of the calculations is that with a high level of groundwater there is a small remaining upward force when no transformer is present. The adhesive force from the surrounding soil will be amplified by the cooling fins so the risk of floating is minimal.

Attaching the object to a foundation is also a solution to prevent floating.

Water tightness

Groundwater is often present in weak soil with varying from just under the pavement till much deeper. Resistance against groundwater is accomplished by using a diving bell principle that is explained in the next figure.

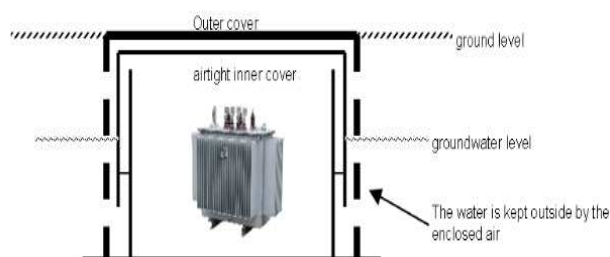

Figure 2: Diving bell principle

The compartment in fact consists of a bottom compartment which is covered by an airtight inner cover. Because of the air that is present underneath the inner cover the ground water is kept outside.

Apart from the diving bell principle the compartment has been equipped with a possibility for connecting it to a sewer system.

Thermal behaviour

Probably the biggest challenge is dealing with the heat generated by the transformer due to losses. This heat has to be drained, otherwise temperatures will rise to unacceptable values. We want to be in control of temperatures because temperature is the limiting factor for transformers. The demand “no ventilation shafts” means that the heat mainly has to be transferred through the surrounding soil. Perhaps a little heat can be transferred by the cover of the compartment but this will only be a small contribution.

Processes and parameters

The process of heat draining is complex and consists of several sub processes, the main ones are:

- Production of heat
- Conducting heat from transformer to the wall of the compartment
- Transferring heat from compartment to surrounding soil
- Transferring heat to the air above the compartment or extra heating by sunlight

The processes depend on a number of parameters, the most

important ones are:

- Transformer specifications
- Transformer load and loading curve
- Time constants
- Air temperature
- The conductivity of the soil
- The temperature of the surrounding soil

Transformer specifications

When it comes to distribution transformers there is one mayor choice:

- Oil immersed transformers
- Casting resin transformers (“dry transformers”)

Casting resin transformers produce more heat due to higher losses, are more sensitive to overloading and are more sensitive for moisture than oil immersed transformers. The choice in this case is clear. The presence of oil and the higher weight of an oil immersed transformer are not a problem for use in an underground compartment.

There is a strong urge to use a standard transformer because of interchange ability, low cost and other advantages.

In the Netherlands the bigger part of distribution transformers, purchased and operated by the DSO’s, are built according to a joint standard.

An extract of the Dutch standard concerning the maximum losses of three types of transformers is shown in the table.

	250 kVA	400 kVA	630 kVA
No load losses (W)	365	515	745
Load losses (W)	2640	3750	5200

Table 1: Maximum losses of standard transformers

Another important parameter from the Dutch standard transformers is the choice for “A class” isolation. Conform the IEC 60076-7 (loading guide for transformers) this type of isolation allows hot spot temperatures of a maximum of 98°C. Above this temperature aging of the transformer rapidly rises.

On a number of distribution transformers, in service in the grid, measurements have been performed to determine the relation between the hot spot and the top oil temperatures. Concluded is that the hot spot temperature is about 9 °C higher than the top oil, for calculations 10 °C difference will be used. This is in accordance with the IEC 60076-7.

Calculations and size

Calculations have more or less shown that the design like presented will accomplish the goal of housing a 400 kVA transformer under normal loading conditions within temperature limits. To take into account are that the processes of heat transferring are complex and might not be completely modelled. Also a number of parameters is not fully known or might vary in an unknown pattern, causing the outcome of the calculations to contain an amount of

uncertainty and probably a deviation from practice.

The presented design has a somehow maximum acceptable size. When the size increases the allocating possibilities and the economic value would decrease gravely.

On these grounds a decision was made to build the compartment and perform extensive thermal testing to decrease the calculation uncertainty and come closest to practice.

Final design

The demands and other issues have led to the final design of the transformer compartment as shown in the next figure.

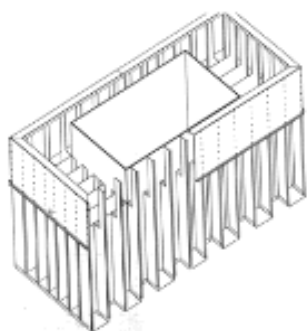

Figure 3: Compartment overview

The compartment has been made from sheet iron with a cast iron outer top cover. Clearly visible are the cooling fins. The outer cover is divided into four parts so manually lifting is possible. For lifting the inner cover a crane is needed. The outside dimensions are 3,3 x 1,5, x 2,2 m (l x w x h). The inner compartment, the transformer room, stands 1,75 x 1,00 x 1,94 m. This makes it possible to use a transformer of a maximum of 800 kVA.

THERMAL TESTING

After constructing the transformer compartment, it was installed on the test site. It was placed in so called back-fill sand to ensure a good transfer of heat. After installing a number of tests were performed during a 10 months period.

Imitation transformer

Performing a long term test with a real 10/0,4 kV transformer is hard. Besides working with live medium voltage a controllable load is necessary. To produce realistic losses the load should be adjustable up to 400 kVA. Instead of using a real transformer the tank of an old one was used. A number of heating elements with different capacities was installed in the oil filled tank. The advantage of this combination is that only the relatively small losses have to be controlled for.

Thermal testing results and analyses

In general two test types are performed: heating with a constant capacity and heating with a varying capacity matching the losses of a transformer with a day pattern load.

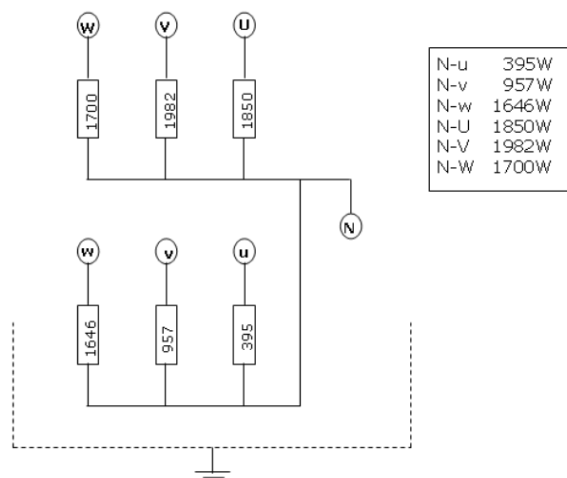

Figure 4: Heating elements in transformer tank

Also the maximum load in the day pattern varies. For the day pattern losses the chosen time distribution of the losses is represented in the next table.

Time interval (hr)	7:00 - 10:00	10:00 - 16:00	16:00 - 19:00	19:00 - 7:00
Losses (W)	max	0,67 max	max	0,33 max

Table 2: Losses with day pattern load

Heating with a constant load was done to determine the system time constant. The measured time constant is 20 hours, calculated was 21,5 hours.

Like predicted, next to the simulated losses, the outside temperature has a great influence at the oil temperature inside the transformer tank. Clearly visible is that the highest oil temperatures are reached on hot sunny days. Top oil temperatures are higher than calculated, probably because of extra heat production due to incident sunlight on the outer cover. When the limit for the top oil temperature is set on 100 °C the maximum losses may not exceed 2500 W at the given loading curve. Consequence of choosing 100 °C is that extra aging will occur; this effect will be focussed upon later.

Transformer choice

The limit of 2500 W obliges us to review the transformer before further testing.

The following options were considered:

- Using a standard 630 kVA transformer at max 366 kVA
- Special low loss transformer
- Transformer with a higher isolation class
- Limiting the capacity by using a 250 kVA transformer

The first option was chosen. This option is based upon the fact that the load losses of a transformer are proportional with the quadrature of the load. Although the no load losses of a 630 kVA transformer are higher than those of a 400 kVA one, the total losses are smaller due to the lower copper resistance.

IN PRACTICE

With the knowledge, obtained from the thermal tests, live testing has started.

For the live test a location is chosen next to a conventional man-accessible 10/0,4 kV station with a load of approximately 350 kVA. The underground transformer is connected redundantly with the grid so that at all times its function can be taken over by the existing station. The station is placed at a spot where it is lighted by the afternoon sun.

A large number of variables is measured and logged. This provides great opportunities for analysing. Also a number of alarms are installed. The main measurements are:

- LV loading current(s)
- Top oil temperature
- Air temperature
- Groundwater level

Thermal testing results and analyses

Live testing is performed since 2007. At this moment we have **complete data over the years 2007- 2010**. Analysing the data shows the following results:

- At this location the groundwater level is of no significance.
- No water leakages or equivalent have occurred.
- Oil temperatures peak in the months July and August and mainly depend on the transformer load and outside temperature in combination with the sunlight.
- The highest temperatures have occurred in the long hot summer of 2009, in the other seasons top oil temperatures are much lower. Focus is on the year 2009.

The form of the daily and weekly load curves are shown in the next figures.

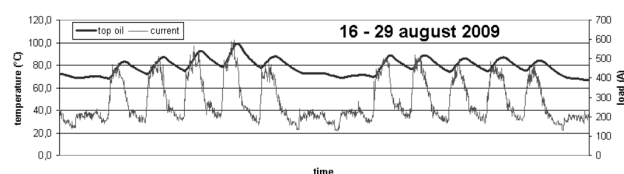

Figure 5: Two week load and top oil temperature curves

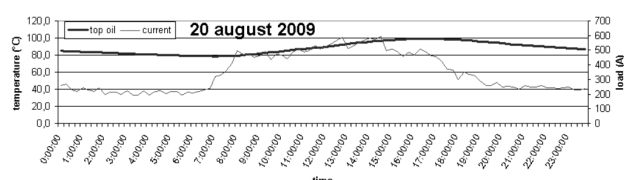

Figure 2: One day load and top oil temperature curves

Clearly visible is that this is a so called “day load” pattern, rising from early morning and dropping in late afternoon. This is typical for a business area. Also visible is that the maximum load is about 600 A equalling 400 kVA. The load is at its maximum at the hottest day of the year and at the

hottest part of the day so this is a sort of worst case test.

Negligible effect from thermal overloading

Especially in July and August the transformer is thermally overloaded. The top oil temperature reaches a maximum of 99 °C at August 20th which means the hot spot temperature was about 108 °C. To prevent aging according to the IEC60076-7 the hotspot temperature is limited to 98 °C. Combined with the 10 °C difference concluded from other tests, this means that when top oil temperatures exceed 88°C extra aging takes place.

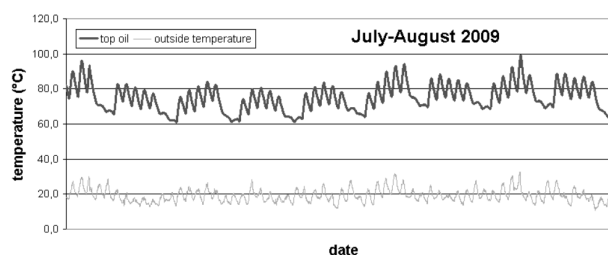

Figure 6: Top oil and outside temperatures

In 2009 the top oil temperatures exceeded the limit of 88 °C during 278 quarters of an hour. The high limit of 105 °C, mentioned in the IEC60076-7, has never been exceeded. Calculated according the IEC60076-7, the overload causes a yearly aging of 109 hour in a period of 69,5 hours (278 quarters). This means that, in the given circumstances, the transformer gets an extra aging of 40 hours each year. This is less than **0,5% loss of lifetime** and is therefore considered acceptable.

CONCLUSIONS

- Building a totally underground distribution transformer is possible using the “diving bell principle” system.
- The load curve and ambient temperature during summer are the decisive parameters for the maximum acceptable load.
- Using a 630 kVA “standard” transformer at a maximum load of 400 kVA gave a good performance but this is near the limit of possibilities. When a higher capacity is needed a special transformer becomes necessary.
- Due to the special compartment and the over proportioned transformer this kind of solution is clearly more expensive than a traditional station. So this solution is only suited for special situations.

REFERENCES

[1] G. Buisman, 2005, *thesis*, college of technology Arnhem and Nijmegen.
 [2] A.F. Mills, 1999, *Heat Transfer 2nd edition*, Prentice Hall, New Jersey, USA.