

## SVC LIGHT WITH ENERGY STORAGE FOR SMART GRIDS

Ervin SPAHIC  
ABB AG – Germany  
ervin.spahic@de.abb.com

Günter STARK  
ABB AG – Germany  
guenter.stark@de.abb.com

Thomas BENZ  
ABB AG – Germany  
thomas.benz@de.abb.com

### ABSTRACT

*Increasing penetration of distributed generation such as wind power and photovoltaic systems as well as expected fast development of electrical vehicles faces existing distribution systems with new challenges such as: power fluctuations, changes of power flow directions, steady state voltage fluctuations etc. These problems can effectively be counteracted by the application of smart power electronic and storage devices. Thanks to their active and independent role the grid itself becomes also smarter.*

*In this paper one solution of a combined power electronic and battery storage system for improvement of grid performance and solving above mentioned raising challenges will be presented, i.e. the SVC Light<sup>®</sup> with energy storage.*

### INTRODUCTION

Driven by the guaranteed feed-in tariffs the electricity produced from the renewable sources in power generation is becoming very significant. This is especially the case with wind power and the electricity produced from photovoltaic. For example in 2010 more than 15 GW of new installed photovoltaic is expected [1].

However, the integration of the renewable sources is facing several challenges such as: volatility of the power production (wind and sun are not always there when wanted) as well as their sudden and abrupt changes. This makes their integration complicated and can jeopardize given targets.

Due to the fact that these renewable sources are not the same as the classical rotating generators, their integration and fulfilling of the grid codes is also an issue (especially for wind turbines). Another difference is their size, i.e. the rated powers of wind turbines and PVs are relatively small comparing to the classical generators. This means that they are usually connected on the distribution network (with exemption of the large wind farms).

Further problem represents the fact that the wind generators and PV are mostly placed in the rural area where no significant consumption exist and accordingly no strong grid. In these cases a special attention has to be given to the voltage conditions and on the power capacity of the feeders if no adequate line connection exists.

Above mentioned issues are some of the problems which renewable sources are facing and, what is very important to be underlined here, these issues are versatile, i.e. of different kinds. Some of the possible solutions which can deal with mentioned issues are:

- improved forecast accuracy of the wind speed and sun/clouds

- making the grid stronger and more robust (new lines)
- introducing new equipment which is able to solve above mentioned problems – power electronics and storages.

Although the improvement of the forecast accuracy is very important, there are plenty of the cases where the forecast is not able to give information on the wind changes (about wind boost or real time wind fluctuations) or on the small clouds which can strongly impact the PV production.

In the rural areas with high wind and/or PV generation, building of new lines could be a solution, but this could be cost effective and, in case of overhead lines, very difficult – due to the opposition of the local communities.

By using modern power electronic devices such as SVC Light<sup>®</sup> and storages the grid can profit from their good characteristics and easier integrate the renewable energy sources in the grid. Their flexibility and possibility for active and reactive power control can crucially contribute towards smart grids.

According to their application the storages for the application in electrical power systems can be divided in a two major groups: storages for power and energy application [2]. The storages for power application (flywheels, capacitors, superconducting energy storages and batteries) should have very short access time (milliseconds) and be able to supply/store high amount of power for short time (seconds up to several minutes). On the other hand, the storages for energy application (pump hydro storages, compressed air energy storages, hydrogen and batteries) do not need to have fast acting time, but they have to be able to supply/store the energy for several hours up to days.

The batteries can be used for both power and energy application – thanks to their modular design. Due to their excellent features (high efficiency, long life-time, high power density, very fast development etc.) the Li-Ion batteries are used together with SVC Light<sup>®</sup> (STATCOM based on the IGBT technology).

### SVC LIGHT<sup>®</sup> WITH ENERGY STORAGE

SVC Light<sup>®</sup> is connected in parallel to the existing electrical grid and uses power electronics to regulate the voltage of the network. This is being done by the control of reactive power at its output - production or consumption of reactive power. Therewith the SVC Light<sup>®</sup> is enabling the voltage control at the connecting point and surrounding nodes [3]. Furthermore, thanks to very fast acting time SVC Light<sup>®</sup> is also able for dynamic voltage support of the system (attenuate transient power swings).

The SVC Light<sup>®</sup> is based on the concept of power electronic voltage source converter (Voltage Source Converter, VSC) with IGBTs. This enables their fully controllability (independent from the grid) and the use of pulse width modulation (PWM). This concept is characterised by: voltage support / reactive power compensation;

compensation of the power factor; compensation for asymmetric and fluctuating loads; damping of power swings; active filtering of harmonics etc. Energy storage build by the Li-Ion batteries is integrated with the SVC Light<sup>®</sup> and than connected to the power system – it is called DynaPeaQ<sup>®</sup>. More details and description of the system can be found in [4] and the first results from the pilot project in [5]. The principal scheme of the entire system is shown in Figure 1.

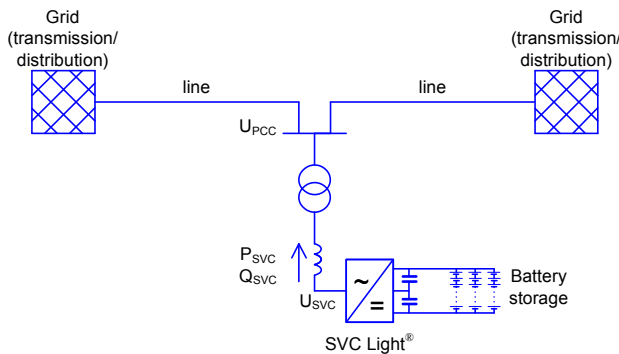
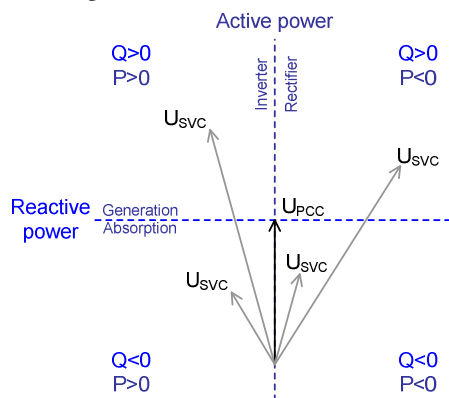

**Figure 1.** Principal scheme of SVC Light<sup>®</sup> with battery storage.

The power and energy of the battery storage is sized depending on the particularly requirements and the purpose of the application. For the dimensioning of the battery it is very important to know how often it has to be charged/discharged and the power and energy thereat. For example, a Li-Ion battery at 100% load can be discharged 4,000 times to 20%. If this occurs once a day the life time of this battery will be approximately 11 years. On the other side, if the same battery is 25 times per day discharged for only 3% and afterwards fully charged, than she can be in operation for 20 years. So the exact investment costs are strongly dependent on the storage task. This was also confirmed in the study of VDE [6], where the specific costs vary for different tasks.

Together with above mentioned features of the SVC Light<sup>®</sup> the batteries are adding the system following characteristics: active power control; black start capability; island operation of small systems; grid support during contingencies; load management; frequency control etc.

The operation modes of SVC Light<sup>®</sup> with battery storage are shown in Figure 2.



**Figure 2.** Various operation points of the SVC Light<sup>®</sup> with battery storage.

As it can be seen operation in all four quadrants of a P-Q diagram are enabled. By controlling of the phase and magnitude of the output voltage  $U_{SVC}$  the SVC Light<sup>®</sup> with energy storage can operate as inverter/rectifier of active power (battery is being discharged/charged) as well as generator/absorber of reactive power. Off course, if  $U_{SVC}$  is in phase with referent voltage  $U_{PCC}$  than only the exchange of the reactive power will be enabled. Similar, if the magnitudes of the reference voltage  $U_{PCC}$  and output voltage  $U_{SVC}$  (considering angle between them) are equal, than there is only active power exchange at the PCC.

Active and reactive power exchanges depend on the magnitude and phase of voltages at the PCC and at the output of the SVC Light<sup>®</sup>:

$$P_{SVC} = \frac{U_{PCC} \cdot U_{SVC}}{X} \sin(\delta_{PCC} - \delta_{SVC}) \quad (1)$$

$$Q_{SVC} = -\frac{U_{SVC}^2}{X} + \frac{U_{PCC} \cdot U_{SVC}}{X} \cos(\delta_{PCC} - \delta_{SVC}) \quad (2)$$

By using PWM to control the firing of the IGBTs the changes of magnitude and the phase of the output voltage can be chosen – Figure 3.

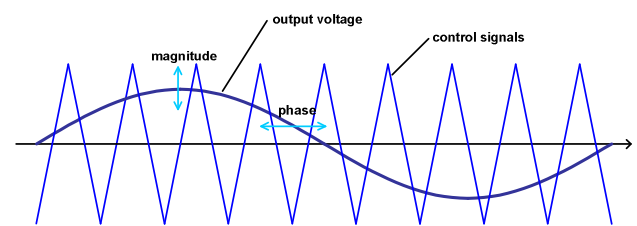
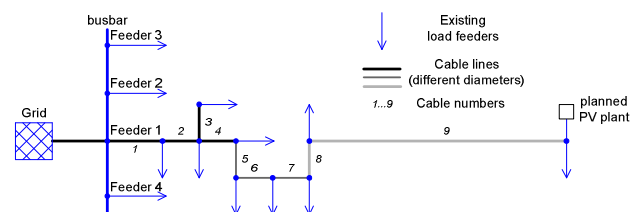

**Figure 3.** Control signals and output voltage of SVC Light<sup>®</sup>.

According to the actual needs the output voltage  $U_{SVC}$  can be changed independently of the grid situation – it is flexible. So if there is a change in the grid voltage the SVC Light<sup>®</sup> can immediately act and adapt its output voltage. Therewith the SVC Light<sup>®</sup> with energy storage is able to operate not only in different P-Q quadrants but also in different grid conditions and enable the grid support.

### DEMONSTRATION CASE

In order to demonstrate some of the capabilities of the SVC Light<sup>®</sup> with energy storage a part of the real power grid was simulated – Figure 4.



**Figure 4.** Test system for demonstration of the impact of SVC Light<sup>®</sup> with energy storage.

At the end of existing Feeder 1 a new PV power plant is planned. It has to be noted that existing cable feeder is

supplying a relatively small and remote consumers. At the beginning of the feeder 1 the cable diameter is larger but at the end the cable was dimensioned according to the small consumption at the remote consumers.

**Congestion mitigation**

When considering the power capacity of the cables, the cables 8 and 9 will not be able to transmit the maximum peak power which will be produced from the planned PV plant. Since the maximum capacity of the cable is in given case over exceeded for approximately 10% there is the possibility to cap the excessive production from PV plant. On the other hand there is the possibility to build a new cable line or to increase the capacity of the existing cable line (replacing old cable). In Figure 5 the production from the PV plant and the energy/power which can not be fed into the grid by using existing cable connection have been shown.

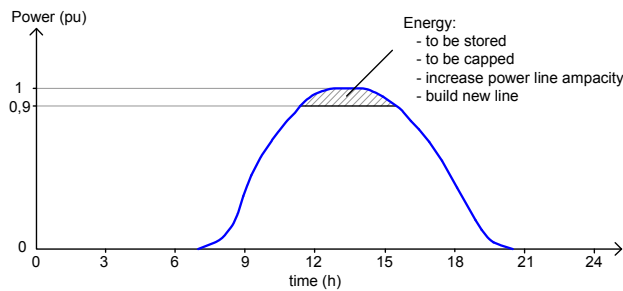

**Figure 5.** Daily PV generation curve and the surplus of power/energy for analysed case.

As already mentioned, the application of the SVC Light<sup>®</sup> with battery storage is also an option. In order to reduce the investment costs the battery can be dimensioned only for 10% of the PV plant. If needed the battery storage can be extended by battery modules.

For analysed case shown in Figure 4, an economical comparison of all three solutions was performed. So in Figure 6 the ratio of costs for building new line, application of SVC Light<sup>®</sup> with battery storage as well as costs of capping of PV production is given.

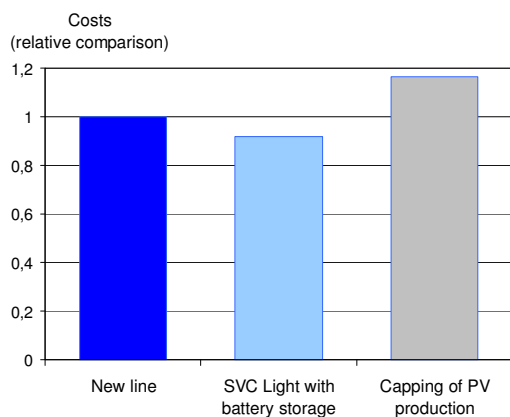

**Figure 6.** Comparison of costs for different solutions by connecting PV plant.

In given case is shown that the application of SVC Light<sup>®</sup> with battery storage has the lowest costs. Building a new line is more expensive. Capping of PV production, if this is a solution - considering political drives and decisions, has the highest costs (not obtaining the guaranteed feed-in tariffs for produced PV energy).

In order to get the accurate estimation of the costs and the comparison of different solutions, several factors have to be considered: costs for the new line (or lines) which has to be built ( $K$ ), rated power of the SVC Light<sup>®</sup> ( $S$ ), power ( $B_P$ ) and energy ( $B_E$ ) of the battery, feed in tariffs ( $F$ ), power losses ( $L$ ), observed time (life time cycle costs). The costs optimisation function can be written as:

$$f(x) = \min \begin{bmatrix} K(x) \\ S(x) \\ B_P(x) \\ B_E(x) \\ F(x) \\ L(x) \end{bmatrix} \quad (3)$$

subject to:

$$g_i(x) \leq 0 \quad \text{where } i=1,2,\dots,m$$

$$h_j(x) = 0 \quad \text{where } j=1,2,\dots,n$$

As it can be seen the results strongly depend on the given framework. It can be said that if the line length is shorter, than the solution of building new line would be less expensive. Furthermore, if the exceeding power and energy are higher, than the battery has to be bigger, which leads to higher costs of this solution. Very interesting result that can occur is that it could be more economical to cap the production from the PV plant instead of building new lines or e.g. SVC Light<sup>®</sup> with battery storage.

Optimisation function can be extended with e.g. CO<sub>2</sub> certificate costs or some other factors.

**Voltage conditions**

Beside the problems with the congestion of the cable lines, further problem is the voltage fluctuation. In given case at the maximum power supply from the planned PV plant the voltage at the feeder end will increase and amount app. 106,6% of the nominal voltage – Figure 7.

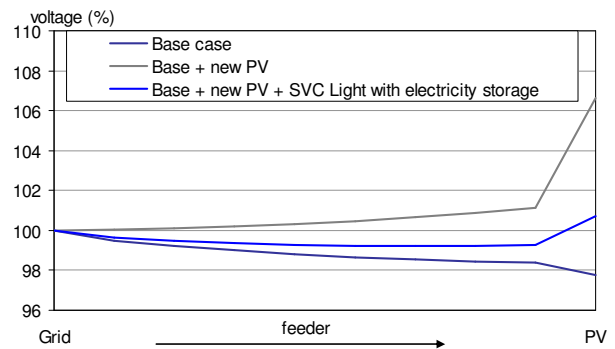

**Figure 7.** Voltage along Feeder 1 in three different cases at the peak power production from the planned PV plant.

If the SVC Light<sup>®</sup> with battery storage will be connected the voltage increase at the end can be smoothed and returned within given limits. Again, with the setting the control signals of the SVC Light<sup>®</sup> (modulation signals controlling the magnitude and phase of the output voltage) the voltage can be regulated at the desired value.

A feature that the SVC Light<sup>®</sup> is "feeding" the grid with reactive power can be used alternatively depending on the voltage conditions i.e. amount of the power which is produced by the PV plant. In Figure 8 the real time voltage control is shown.

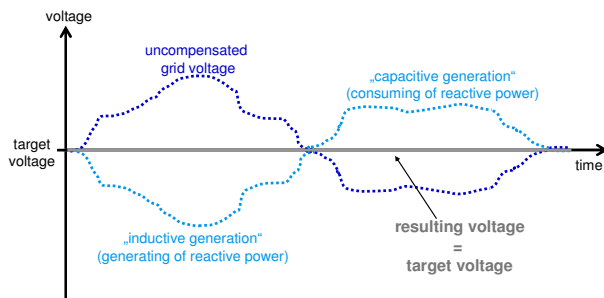
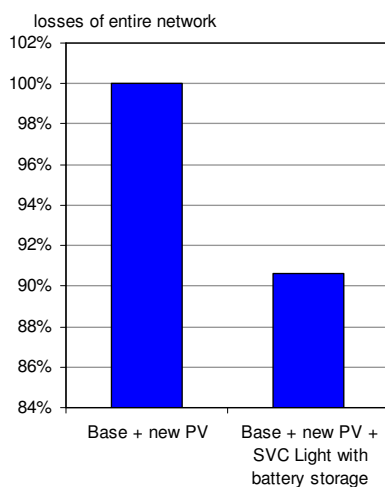

**Figure 8.** Real time voltage control by SVC Light<sup>®</sup> with battery storage.

Depending on the voltage conditions in the grid i.e. on the controlled node, the SVC Light<sup>®</sup> can act as a generator or consumer of the reactive power and, therewith, set the voltage at the controlled node at the target value.

### Power losses

Additional benefit when using SVC Light<sup>®</sup> with battery storage in a given demonstration case is the reduction of the power losses. As known, the power losses are proportional to the square of the current. By With the reduction of the peak power i.e. maximal current the losses can be reduced significantly – Figure 9.



**Figure 9.** Reduction of the power losses.

In given case the power losses in the entire grid are reduced for almost 10% and in the Feeder 1 for approximately 17%.

### CONCLUSION

Performed analyses show that SVC Light<sup>®</sup> with battery storage (DynaPeaQ<sup>®</sup>) represents a very good solution and an alternative for integrating volatile renewable generation. Given example is based on the integrating of the PV plant. Since wind generation has similar volatile behaviour and, therewith, causes similar problems in the grid, the analogue conclusions can be assumed.

Depending on the given framework and project characteristics the application of the SVC Light<sup>®</sup> with battery storage can be more cost effective than building a new cable line. Furthermore, the voltage limits can be held within limits and voltage fluctuations smoothed and set to the target value. Power losses are in given case reduced for almost 10% in entire network.

The financial benefit of using the SVC Light<sup>®</sup> with battery storage increases when the overall picture which comprises analysed applications (congestion mitigation, voltage fluctuations and power losses) as well as some in this paper not analysed ones (like fulfilling grid code requirements, auxiliary services for the grid etc.) is considered.

### REFERENCES

- [1] GTM Research, *PV Technology, Production & Cost Outlook: 2010-2015*, 2010.
- [2] E. Spahic, *et al*, 2007, "Wind Energy Storages – Possibilities", *Proceedings IEEE Power Tech Conference*, Lausanne, Switzerland.
- [3] R. Grünbaum, 2000, "SVC Light: a powerful means for dynamic voltage and power quality control in industry and distribution", *Eighth Int. Conf. on Power Electronics and Variable Speed Drives*, London, UK.
- [4] J. Svensson and W. Hermansson, 2008, "Dynamic Energy Storage using SVC Light", *CIGRÉ conference*, paper B4-204, Paris, France.
- [5] N. Wade, *et al*, 2009, "Energy Storage for Power Flow Management and Voltage Control on an 11 kV UK distribution Network", *20<sup>th</sup> CIRED conference*, paper 0824, Prague, Czech Republic.
- [6] VDE, *Energiespeicher in Stromversorgungssystemen mit hohem Anteil erneuerbaren Energieträger (in German)*, 2008.